



# INTREPID

FLAGSHIP STORES

STORE SET UP GUIDE

# INTREPID

## STORE SET UP GUIDE

This guide has been designed to assist you in displaying your Intrepid rooftop tent in store.

To ensure consistency across our network, please follow the directives outlined in this guide.



# INTREPID

## IN -STORE COLLATERAL

Base deck signs will be sent to flagship stores with your camping campaign collateral

### WHAT YOU WILL RECIEVE

FRONT



REVERSE



### WHAT YOU WILL NEED



Base Deck  
(Reused from previous promotions  
or  
can be ordered from main  
570169)



Base Deck  
Sign  
(Double sided)

x 1



# INTREPID

## DISPLAY OPTIONS

There are 3 display options available to display the new Intrepid tent in /at store

DISPLAY STAND



MITs DISPLAY



BRANCH VEHICLE DISPLAY

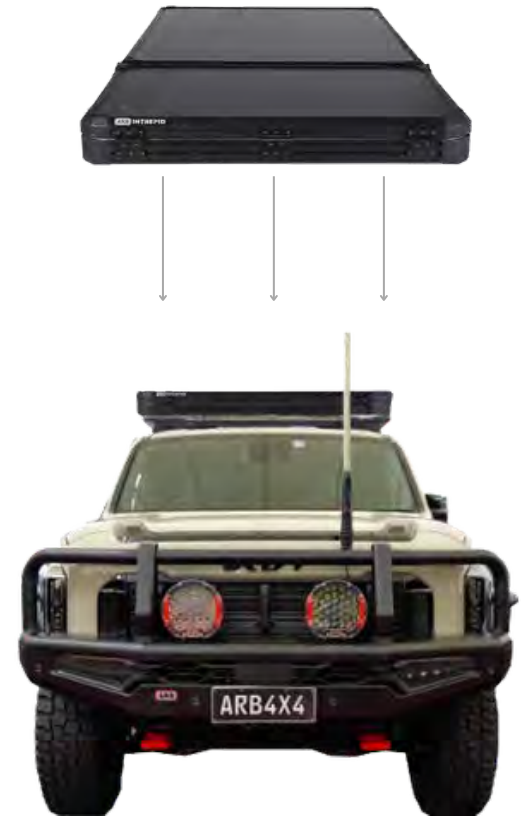

(To be displayed outside the store)

# INTREPID

## IN-STORE DISPLAY

Stores that have the room to install an intrepid tent on a display stand will require the following:

- ▶ **Part no:** 802610 ARB INTREPID SLIMLINE ALUMINIUM RTT

### ADDITIONAL ITEMS:

---

- ▶ **Part no:** 217995 ALTITUDE TENT DISPLAY STAND
- ▶ **Part no:** 1770100 BASE RACK
- ▶ **Part no:** 6177545 BASE RACK FIT KIT

### FLOOR DISPLAY:

---

- ▶ Base Deck Sign (Double sided)
- ▶ **Part no:** 570169 Base Deck holder



**ARB**  
**Altitude Tent Display Stand**



Note: the colors are for illustrative purposes only



THE IMAGES SHOWN ON THIS PAGE ARE CONCEPTUAL ONLY, AND MAY BE SUBJECT TO CHANGE IN ORDER TO SUIT A PARTICULAR MANUFACTURING OR TRANSPORT REQUIREMENT.



Back and Front elevation



Top and Side elevation

02/10/2024

THE DESIGNS & CONCEPTS SHOWN ARE THE PROPERTY OF  
SI RETAIL Pty Ltd. NO PART MAY BE SHOWN, QUOTED OR  
REPRODUCED TO ANY THIRD PARTY WITHOUT PRIOR  
WRITTEN PERMISSION FROM SI RETAIL Pty Ltd.

COPYRIGHT © 2023

# INTREPID

## IN-STORE DISPLAY

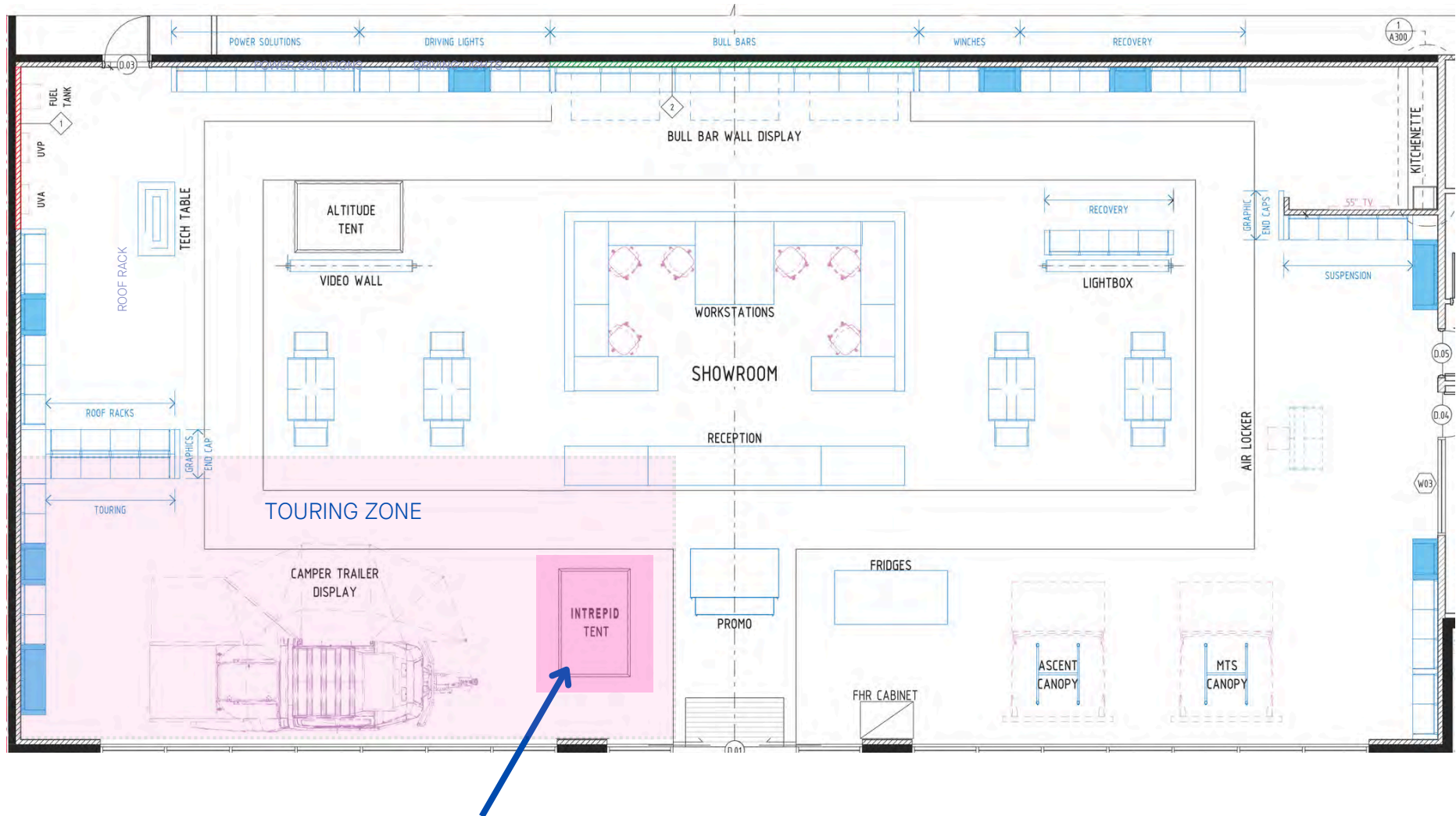

The preferred location of the Intrepid tent display stand, is located within the Touring zone within your store. This is a suitable location for those stores that have the available floor space.

# INTREPID

## MITS DISPLAY



\*Photo is an example only,  
please follow descriptions

CURRENT MITS IN-STORE DISPLAY  
(Stores that don't yet have a MITS display in-store can use this parts list)

INTREPID	
802620	ARB Intrepid Slimline Aluminium RTT
A2RM1APK1	MITS 1870MM MULTI RACK X 3
4100006	MNT KIT ROOF TOP TENT SQ/HD

MITS DISPLAYS	Colour code: PMYHR , Aluminium Metallic
217996	ARB CANOPY DISPLAY STAND
TCP21AB1AA	MITS EV2 DC TRAY+1.5M CNPY
AUTBR1900S	MITS U/TRAY TBOX 900 OFFSET
A2TMG1A1S	MITS M/GLIAB SET 35 IN
EL6	MITS REDARC UL TI MATE PK
IP219A	MITS INT. PACK 9 SUIT 850H
A2RMABK1	MITS MLTI/RK UNIV. AWN BRKT X3
A2RM1APK1	MITS 1870MM MULTI RACK X3
A2RWDP	MITS EVERYDAY REAR WALL PKG
ACCESSORIES	
-	ROH ASSAULT 17" RIM - BLACK
-	MICKEY THOMPSON BAJA BOSS 33 X 12.5 R17
CKBLTA12	ARB TWIN BRUSH LESS COMPRESSOR
171507	ARB AIR TANK
171503	MANIFOLD KIT
814414	ARB BLK ALUM AWN WILIGHT

# INTREPID

## IN-STORE DISPLAY



The Intrepid base deck sign is to be displayed beside the Intrepid tent

### Ladder usage

The ladder must not be accessible for climbing into the display due to the height of the display stand

# INTREPID

## IN-STORE DISPLAY

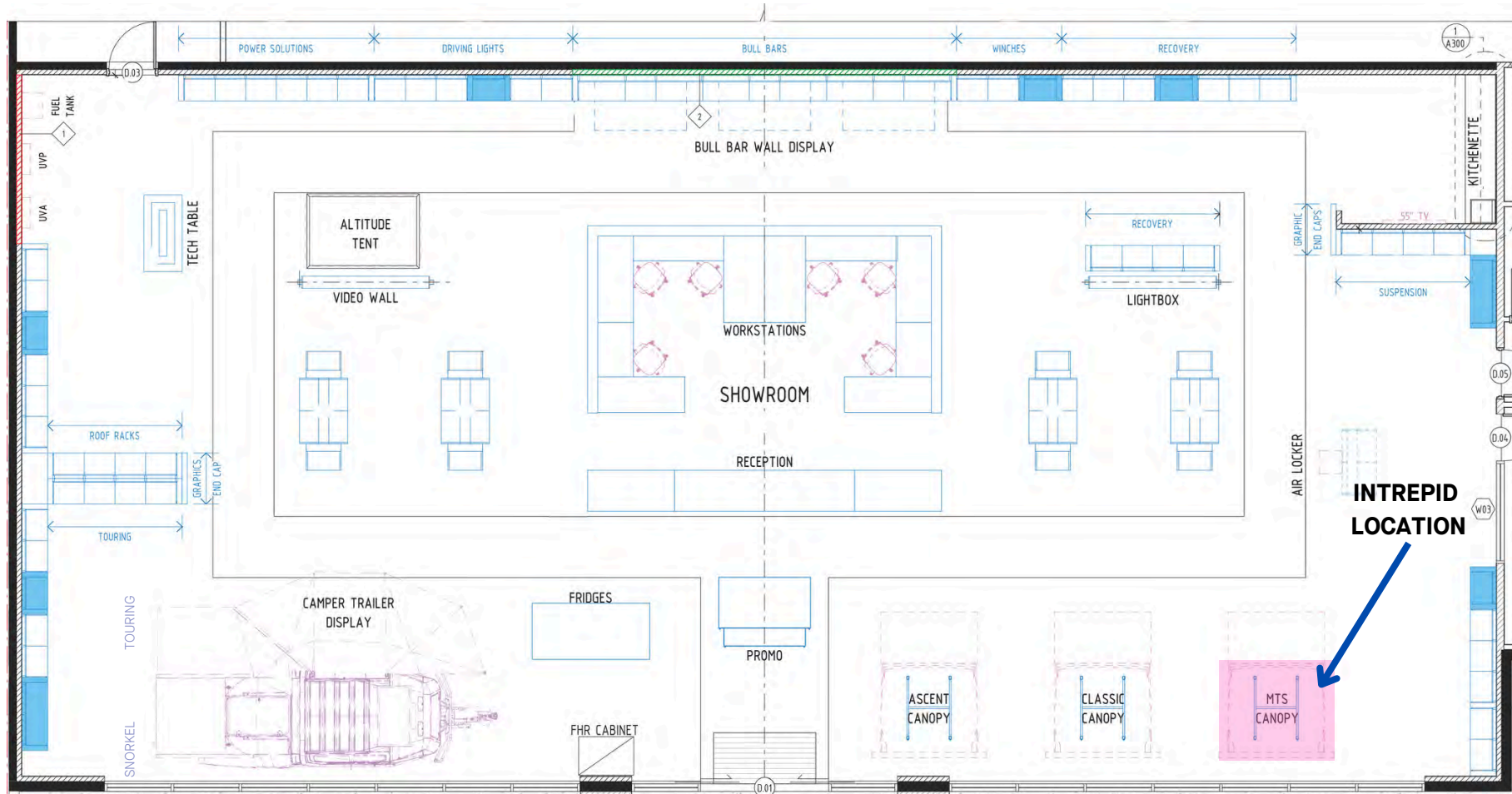

The Intrepid RTT can also be displayed on the MIT's display. This is a suitable location for those stores that have limited floor space, but still wish to have the tent on display.

# INTREPID

IN-STORE DISPLAY

Limited space option:

## BRANCH VEHICLE

If showroom floorspace is limited, the Intrepid can be mounted to a branch vehicle.



### Safety Matters - Ensuring everyone stays safe is a priority in all we do

It is our priority as a business to ensure that we all stay safe



### FITTING INSTRUCTIONS

**Please refer to the fitting instructions supplied. Please follow all safety procedures and processes when fitting the tent to the display stand.**

#### ✔ Operating the tent



- DO NOT operate tent with occupants inside the tent
- Observe pinch point warning labels when opening and closing the tent
- Ensure all casters are locked once the stand is in place. Casters are to remain locked at all times.
- Please ensure there is enough clearance to open the tent, and it is clear of obstructions such as overhead lighting.

#### ✔ Load rating

- The SWL (Safe Working Load) of the Altitude display stand is 300kg
- The SWL (Safe Working Load) of the MITS stand is 500Kg
- Ensure the Display stand is not overloaded including product or people.
- **TO COMPLY WITH THE SWL, ALL WEIGHT MUST BE EVENLY DISTRIBUTED ON THE STANDS**

#### ✔ Ladder usage

- Where the ladder is displayed, it must not be accessible for climbing into the display due to the height of the display stand.

-  Do not operate the tent near an open flame or heat source nor use any product that burns fuel in the tent.  
At all times, take precautions that there are no flames, or other heat sources, near the tent fabric or mattress. Neither the tent nor the mattress are fire retardant.
-  Deadly fumes produced by stoves, lanterns, grill, heaters, or fire pits can build up inside of the tent and cause potential illness or even death.
-  Do not pull on the strut to enter the tent, and do not lean on the strut for back support. Any bend in the strut could make the tent non-functional and void the warranty.

# APPENDIX

ITEM NO.	PART NUMBER	DESCRIPTION	QTY.
1	2170486A4	SIDE BOTTOM MEMBER, ALTITUDE DISPLAY STAND	2
2	2170486A1-100	VERTICAL MEMBER, ALTITUDE DISPLAY STAND - LEFT	2
3	2170486A1-100	VERTICAL MEMBER, ALTITUDE DISPLAY STAND - RIGHT	2
4	2170486A2	SIDE TOP MEMBER, ALTITUDE DISPLAY STAND	2
5	2170486A3	HORIZONTAL MEMBER, ALTITUDE DISPLAY STAND	4
6	2170486A13	CASTOR MOUNT, ALTITUDE DISPLAY STAND - RIGHT	2
7	2170486A13	CASTOR MOUNT, ALTITUDE DISPLAY STAND - LEFT	2
8	2170486A3	HORIZONTAL MEMBER, ALTITUDE DISPLAY STAND	2
9	M8X30mm	M8x30mm FURNITURE BOLT BLACK ZINC	40

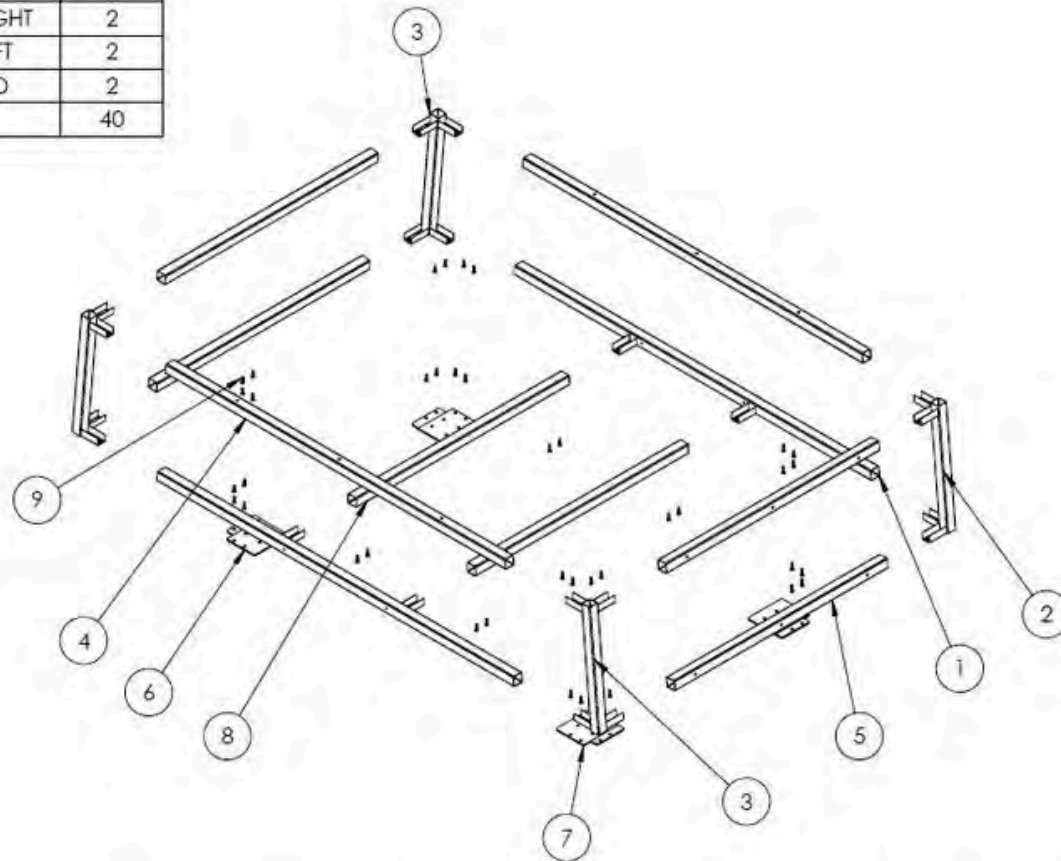

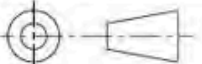
 <p><b>SOLUTIONS IN RETAIL</b></p> <p>UNLESS OTHERWISE SPECIFIED, ALL DIMENSIONS ARE IN MILLIMETRES.</p> <p>FOR DIMENSIONS WHERE TOLERANCES ARE NOT GIVEN, PLEASE USE ISO2768-M MEDIUM.</p> <p>THIS DRAWING MAY NOT BE SHOWN, QUOTED OR REPRODUCED BY ANY OTHER PARTY WITHOUT PRIOR WRITTEN CONSENT FROM SI RETAIL Pty Ltd.</p> <p>DO NOT SCALE FROM DRAWING      COPYRIGHT ©2023</p>	<p>CLIENT: <b>ARB</b></p>	<p>PROJECT No: <b>2170486 FRAME ASSY.</b></p>	<p>MATERIAL: <b>REFER TO PART DRAWINGS</b></p>	<p>DATE: <b>2/10/2024</b></p>	<p>REVISION: <b>A</b></p>
	<p>PROJECT: <b>2170486 FRAME</b></p>	<p>ITEM No: <b>N/A</b></p>	<p>COLOUR:</p>		<p>SCALE: <b>1:20</b></p>
	<p>TITLE: <b>EXPLODED VIEW 2170486 Frame</b></p>	<p>DRAWN BY: <b>PATRICK MORAES</b></p>	<p>FINISH:</p>		<p>SHEET: <b>4 OF 4</b></p>
	<p>DO NOT SCALE FROM DRAWING      COPYRIGHT ©2023</p>			<p>DWG No: <b>2170486 Frame</b></p>	

ITEM NO.	PART NUMBER	DESCRIPTION	QTY.
1	2170486A4	SIDE BOTTOM MEMBER, ALTITUDE DISPLAY STAND	2
2	2170486A1-100	VERTICAL MEMBER, ALTITUDE DISPLAY STAND - LEFT	2
3	2170486A1-100	VERTICAL MEMBER, ALTITUDE DISPLAY STAND - RIGHT	2
4	2170486A2	SIDE TOP MEMBER, ALTITUDE DISPLAY STAND	2
5	2170486A3	HORIZONTAL MEMBER, ALTITUDE DISPLAY STAND	4
6	2170486A3	HORIZONTAL MEMBER, ALTITUDE DISPLAY STAND	2
7	2170486A13	CASTOR MOUNT, ALTITUDE DISPLAY STAND - RIGHT	2
8	2170486A13	CASTOR MOUNT, ALTITUDE DISPLAY STAND - LEFT	2
9	M8X30mm	M8x30mm FURNITURE BOLT BLACK ZINC	40

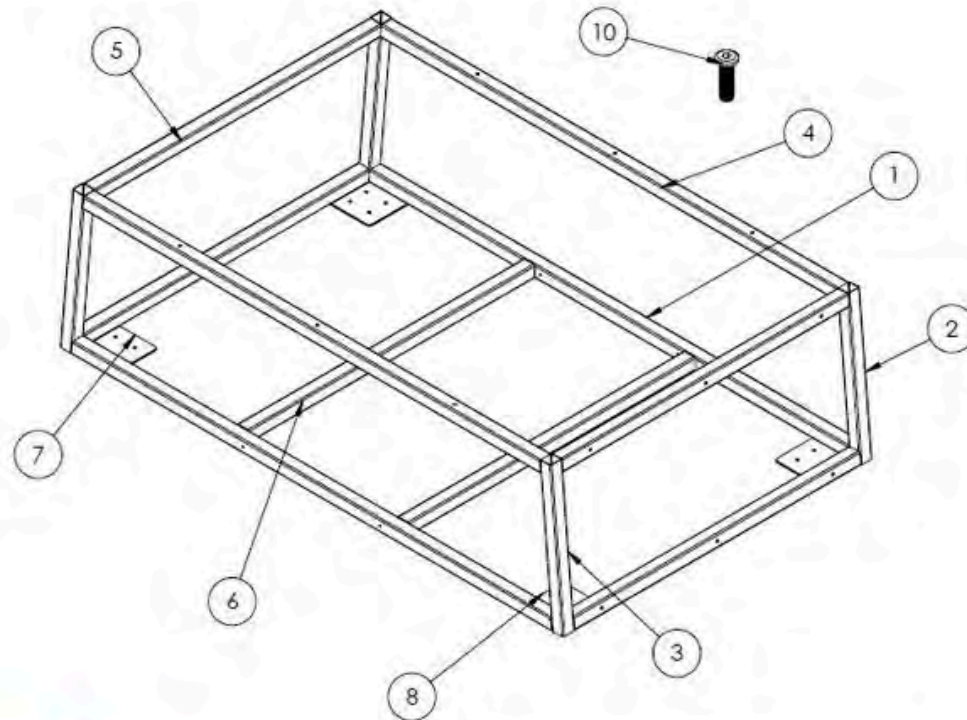
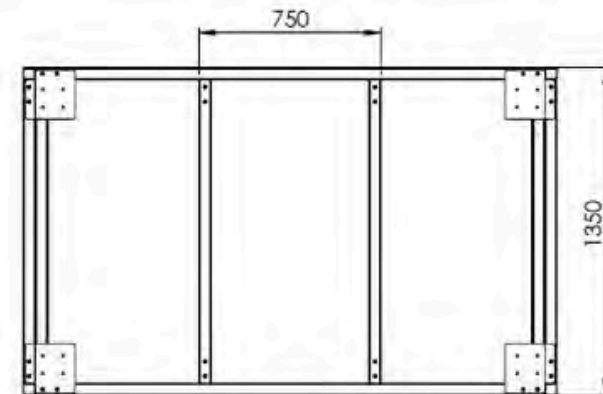
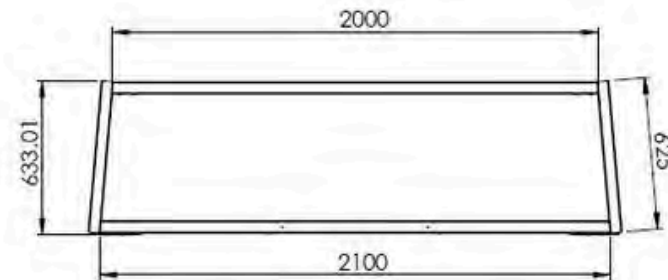
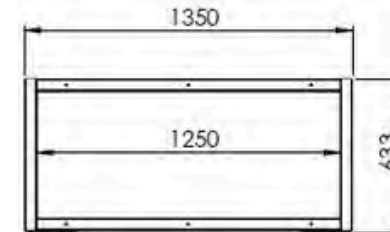

REVISIONS			
REV.	DESCRIPTION	DATE	
A		26/09/2024	1

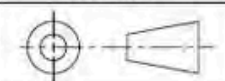

 <p><b>SOLUTIONS IN RETAIL</b></p> <p>UNLESS OTHERWISE SPECIFIED, ALL DIMENSIONS ARE IN MILLIMETRES.</p> <p>FOR DIMENSIONS WHERE TOLERANCES ARE NOT GIVEN, PLEASE USE ISO2768-1 MEDIUM.</p> <p>THIS DRAWING MAY NOT BE SHOWN, QUOTED, OR REPRODUCED BY ANY OTHER PARTY WITHOUT PRIOR WRITTEN CONSENT FROM SI RETAIL Pty Ltd.</p> <p>DO NOT SCALE FROM DRAWING      COPYRIGHT ©2023</p>	CLIENT: <b>ARB</b>	PROJECT No: <b>2170486 FRAME ASSY.</b>	MATERIAL: <b>REFER TO PART DRAWINGS</b>	DATE: <b>2/10/2024</b>	REVISION: <b>A</b>
	PROJECT: <b>2170486 FRAME</b>	ITEM No: <b>N/A</b>	COLOUR:		SCALE: <b>1:20</b>
	TITLE: <b>FULL ASSEMBLY 2170486 Frame</b>	DRAWN BY: <b>PATRICK MORAES</b>	FINISH:		SHEET: <b>3 OF 4</b>
				DWG No: <b>2170486 Frame</b>	

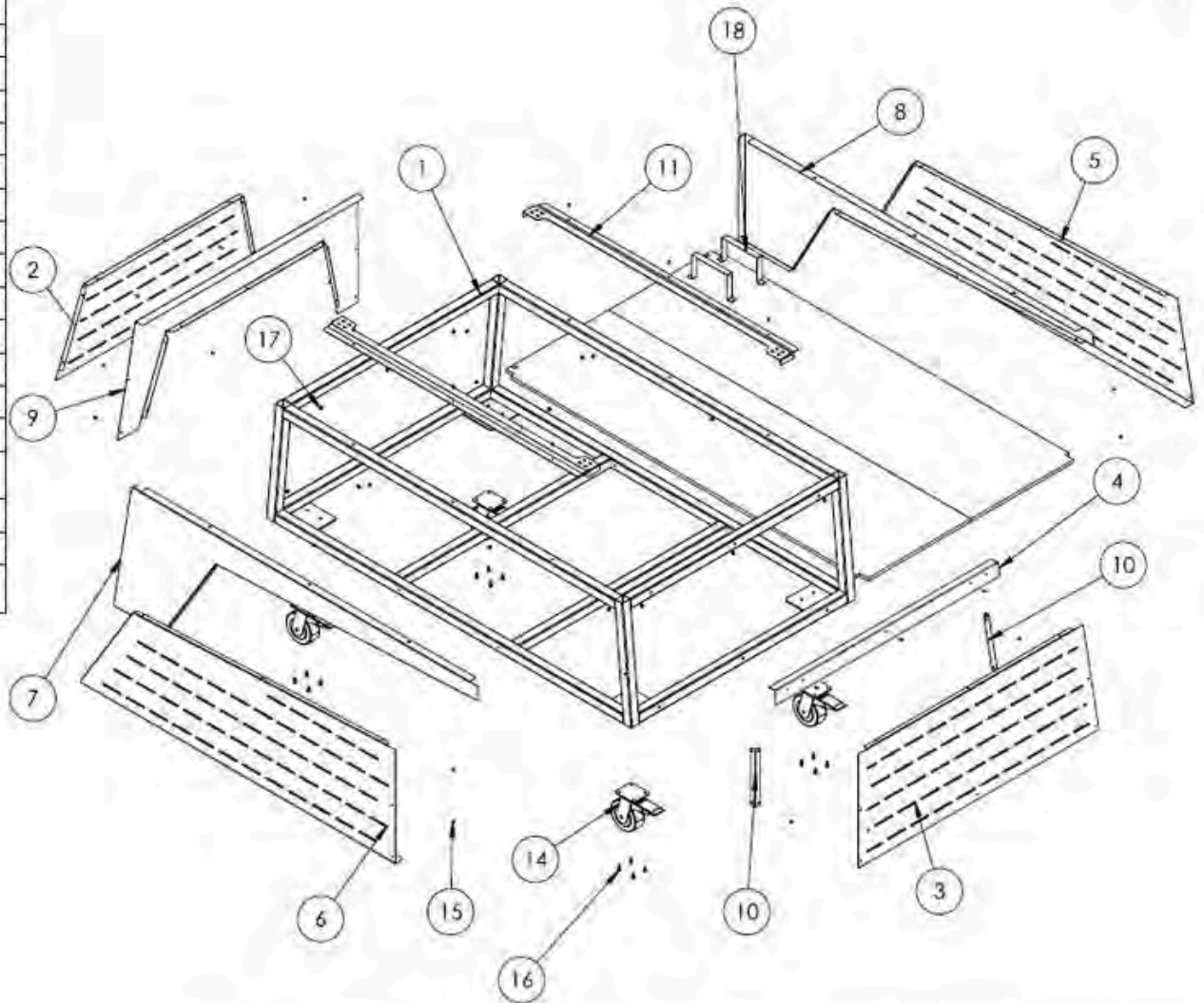
ITEM NO.	PART NUMBER	DESCRIPTION	QTY.
1	2170486	Frame	1
2	2170486A8	CLAD 2 FR	1
3	2170486A6	CLAD 2 FR	1
4	2170486A5	CLAD 1 FR	1
5	2170486A10 LH	CLAD 2 LH	1
6	2170486A10 RH	CLAD 2 RH	1
7	2170486A9 RH	CLAD 1 RH	1
8	2170486A9 LH	CLAD 1 LH	1
9	2170486A7	CLAD 1 RR	1
10	2170486A11	CORNER BRACE	2
11	2170486A12	BASERACK BLADE	2
12	BOARD	LEFT PART	1
13	BOARD	RIGHT PART	1
14	CASTER	150mm WITH BRAKE	4
15	M6x12 BUTTON	M6x12mm SOCKET HEAD BUTTON SCREW	46
16	M8x20mm Hex Head	CASTER BOLTS	16
17	M6 NUT	M6 HEX NUT	20
18	2170486 POWER SUPPLY BRKT	POWER SUPPLY BRKT	2



 <p><b>SOLUTIONS IN RETAIL</b></p> <p><small>UNLESS OTHERWISE SPECIFIED, ALL DIMENSIONS ARE IN MILLIMETERS. FOR DIMENSIONS REFER TO DRAWINGS. PLEASE VISIT <a href="http://www.arb.com.au">www.arb.com.au</a> FOR MORE INFORMATION. THIS DRAWING IS NOT TO BE SHOWN, QUOTED OR REPRODUCED BY ANY OTHER PARTY WITHOUT THE WRITTEN CONSENT OF ARB DISPLAYS PTY LTD.</small></p> <p>DO NOT SCALE FROM DRAWING      COPYRIGHT ©2023</p>	CLIENT: <b>ARB</b>	PROJECT No: <b>2170486 GERAL ASSY.</b>	MATERIAL: <b>REFER TO PART DRAWINGS</b>	DATE: <b>2/10/2024</b>	REVISION: <b>A</b>
	PROJECT: <b>ARB Altitude Tent Display Stand</b>	ITEM No: <b>N/A</b>	COLOUR:	 	SCALE: <b>1:20</b>
	TITLE: <b>EXPLODED VIEW - 2170486</b>	DRAWN BY: <b>PATRICK MORAES</b>	FINISH:	DWG No: <b>2170486A10 LH</b>	SHEET: <b>2 OF 4</b>
					<b>A3</b>

## APPENDIX

ITEM NO.	PART NUMBER	DESCRIPTION	QTY.	
1	2170486	Frame	FULL FRAME	1
2	2170486A8	CLAD 2 FR		1
3	2170486A6	CLAD 2 FR		1
4	2170486A5	CLAD 1 FR		1
5	2170486A10 LH	CLAD 2 LH		1
6	2170486A10 RH	CLAD 2 RH		1
7	2170486A9 RH	CLAD 1 RH		1
8	2170486A9 LH	CLAD 1 LH		1
9	2170486A7	CLAD 1 RR		1
10	2170486A11	CORNER BRACE		2
11	2170486A12	BASERACK BLADE		2
12	BOARD	LEFT PART		1
13	BOARD	RIGHT PART		1
14	CASTER	150mm WITH BRAKE		4
15	M6x12 BUTTON	M6x12mm SOCKET HEAD BUTTON SCREW		46
16	M8x20mm Hex Head	CASTER BOLTS		16
17	M6 NUT	M6 HEX NUT		20
18	2170486 POWER SUPPLY BRKT	POWER SUPPLY BRKT		2

REVISIONS			
REV.	DESCRIPTION	DATE	
A		1/10/2024	8

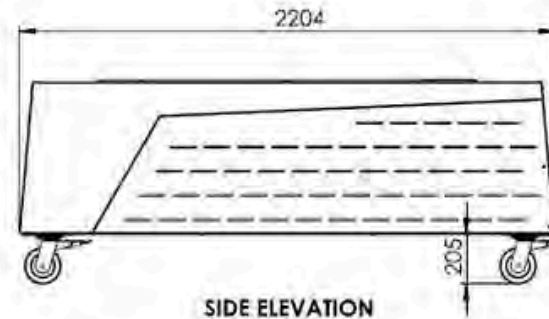

SIDE ELEVATION

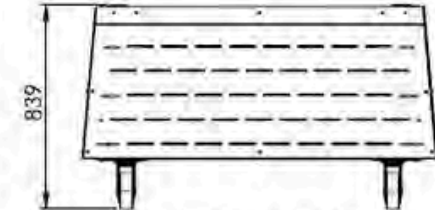

BACK ELEVATION

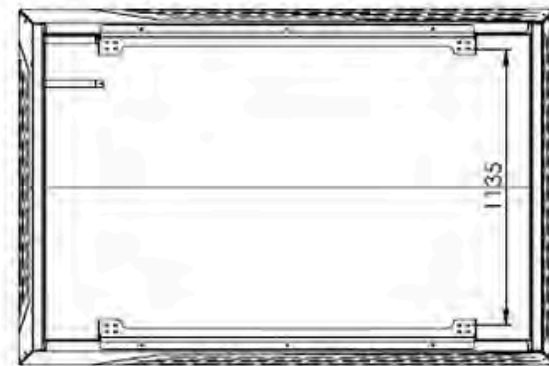

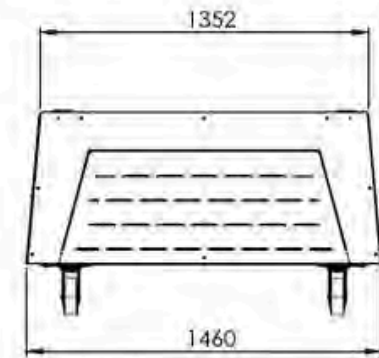

TOP ELEVATION

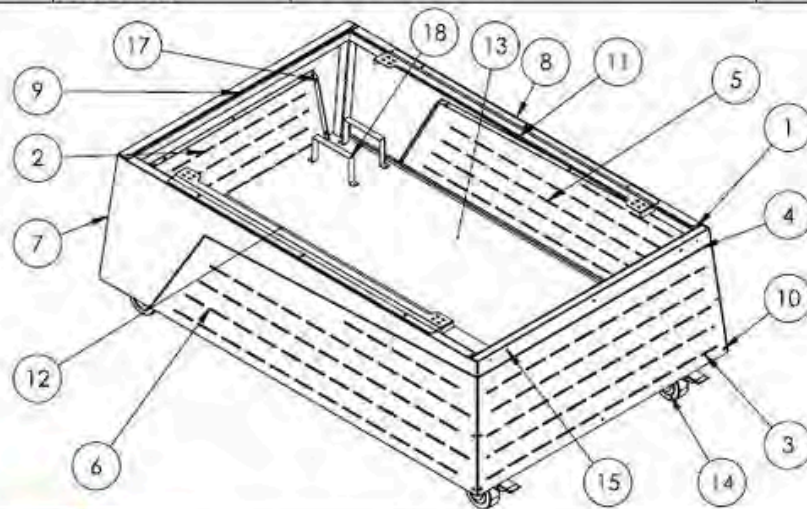

FRONT ELEVATION



 <p><b>SOLUTIONS IN RETAIL</b></p> <p>ALL DRAWINGS ARE TO BE SHOWN COPIED OR REPRODUCED IN ANY FORM, EXACTLY WITHOUT PRIOR WRITTEN CONSENT FROM SI RETAIL PTY LTD.</p> <p>DO NOT SCALE FROM DRAWING      COPYRIGHT ©2023</p>	<p>UNLESS OTHERWISE SPECIFIED, ALL DIMENSIONS ARE IN MILLIMETRES.</p> <p>FOR DIMENSIONS WHERE TOLERANCES ARE NOT GIVEN, PLEASE SEE TABLE 10 (GENERAL)</p>	<p>CLIENT: <b>ARB</b></p> <p>PROJECT: <b>ARB Altitude Tent Display Stand</b></p> <p>TITLE: <b>FULL ASSEMBLY - 2170486</b></p>	<p>PROJECT No: <b>2170486</b></p> <p>ITEM No: <b>N/A</b></p> <p>DRAWN BY: <b>PATRICK MORAES</b></p>	<p>MATERIAL: <b>REFER TO PART DRAWINGS</b></p> <p>COLOUR:</p> <p>FINISH:</p> <p>DWG No: <b>2170486A10 LH</b></p>	<p>DATE: <b>2/10/2024</b></p> 	<p>REVISION: <b>A</b></p> <p>SCALE: <b>1:20</b></p> <p>SHEET: <b>1 OF 4</b></p> <p><b>A3</b></p>
---	---	---	---	--	---	--

# **ARB** INTREPID

SLIMLINE ALUMINIUM ROOFTOP TENT

## **INSTALLATION GUIDE & USER MANUAL**

**ABRIDGED VERSION**

## TENT COMPONENTS

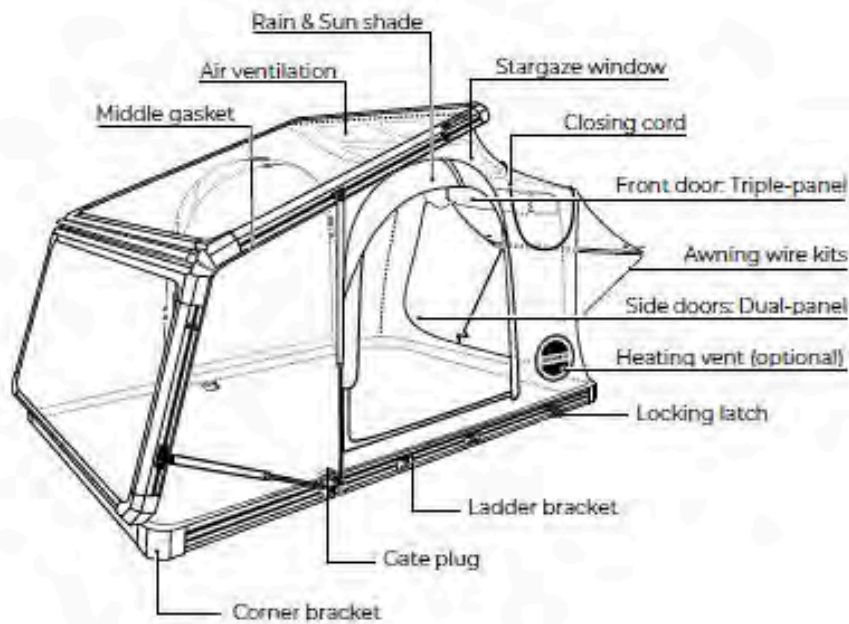
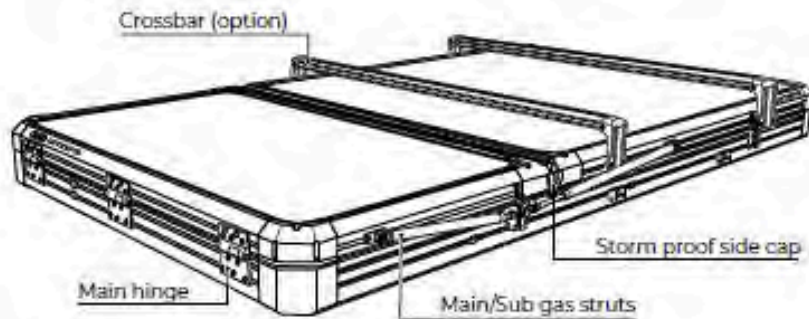

## HARDWARE COMPONENTS (INCLUDED)

Your ARB INTREPID RTT comes with attached latches, a ladder, and a mounting kit with:



1. Tent



2. Vehicle connection brackets  
Stainless steel lock plates



3. Handle + bolts + spring washer



4. Additional M6 T-nut



5. Torx T30IP for bolt M13  
Slim combination spanner



6. 8 step ladder 2.3m

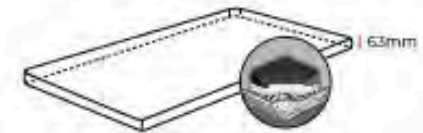

7. Mattress (Condensation-mesh)



8. Ladder bracket  
(1 set equipped on side door)  
Other Parts included



9. Logo plate



10. 5v electrics kit - LED light



11. Awning Wire Kits

**ARB INTREPID**

## CROSSBAR OR PLATFORM

### ADJUSTING THE CROSSBARS

Manufacturer recommendation: distance between crossbars should be **91cm minimum** for more stability while driving. This distance is also recommended between mounting points on platform racks.



### PLATFORM RACKS:

Platform racks can also be used, but may require alternate installation rails. Popular platform racks like Prinsu or Pioneer racks may require brand-specific mounting hardware or alternate methods of installation.

Any additional accessories on crossbar should have a vertical load specification.

### CROSS BARS:

We recommend you purchase heavy-duty, aftermarket crossbars with a dynamic weight rating of at least 75kg. Be sure to check your system's weight capacity and factor in any other equipment or accessories you plan on mounting, to ensure it meets the crossbar's weight recommendation and original car maker's roof rail limit.

## DIMENSIONS AND SPECS 2.0

### INTERIOR DIMENSIONS

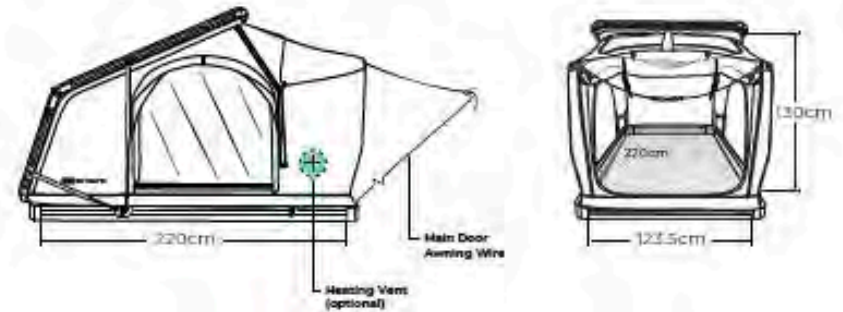

### EXTERIOR DIMENSIONS

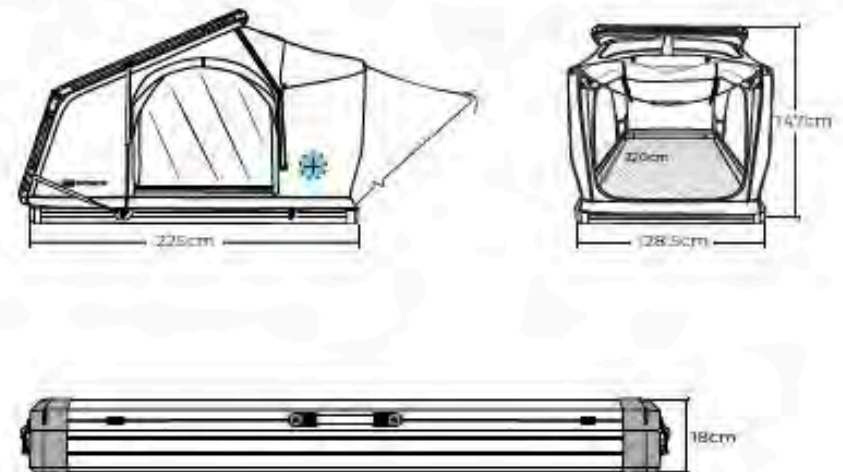

**ARB** INTREPID

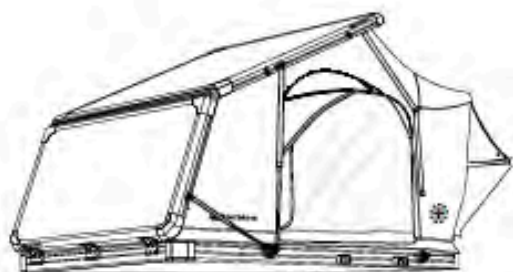

Note: Heavy-duty crossbars should be used when adding extra attachments on top.

- Weight** Tent frame & fabric: 63kg (excluding all detachables)  
 + Mattress & condensation mat: 69kg  
 \* Ladder: 7.5kg
- Interior Dimension** 220cm x 123.5cm x 130cm
- Exterior Dimension** 225cm x 128.5cm x 147cm
- Height Closed/Open** 18cm / 147cm
- Floor** Honeycomb aluminum  
 Aluminum extrusion
- Tent Fabric** **Body Skin fabrics**  
 300D High Tenacity Double-Rip Polyester  
 + 10.000mm Poly Urethane Waterproof back coating  
 + PFAS free water repellent surface coated  
 + Flame Retardant treatment  
 + Ultra-Violet resistant
- Mattress** + Skin - 210D Welded waterproof fabric  
 + Foam - 38mm Poly Urethane, Poly Ethylene, Aluminum insulation triple layer body foam  
 + Condensation Mesh - 15mm Polyester coil spacer.  
 + Total 63mm Thick mattress
- Seasons** 4 Seasons
- Sleeping Capacity** 2 Adult

## DIMENSIONS AND SPECS 2.5

### INTERIOR DIMENSIONS

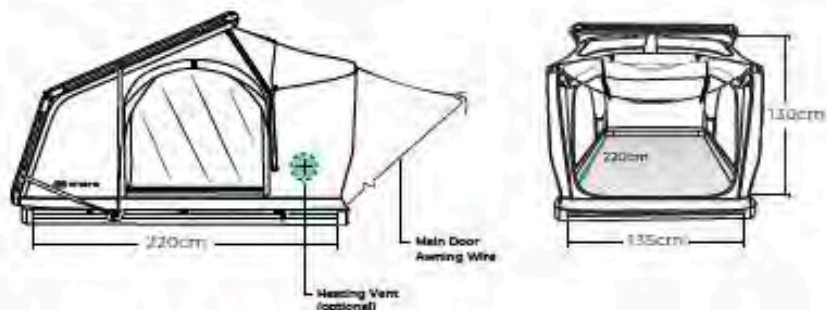

### EXTERIOR DIMENSIONS

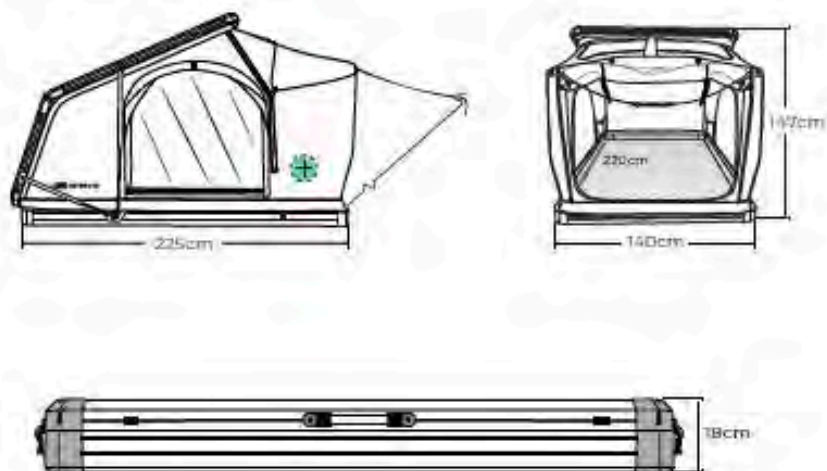

ARB INTREPID

## DIMENSIONS AND SPECS 3.0

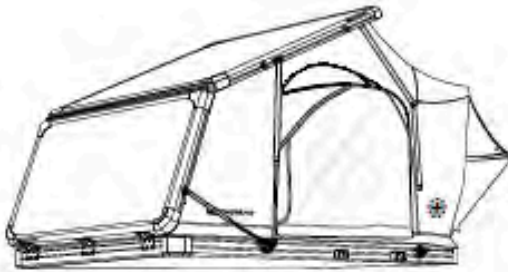

Note: Heavy-duty crossbars should be used when adding extra attachments on top.

<b>Weight</b>	Tent frame & fabric: 68kg (excluding all detachables) + Mattress & condensation mat: 75kg * Ladder: 7.5kg
<b>Interior Dimension</b>	220cm x 135cm x 130cm
<b>Exterior Dimension</b>	225cm x 140cm x 147cm
<b>Height Closed/Open</b>	18cm / 147cm
<b>Floor</b>	Honeycomb aluminum Aluminum extrusion
<b>Tent Fabric</b>	<b>Body Skin fabrics</b> 300D High Tenacity Double-Rip Polyester + 10,000mm Poly Urethane Waterproof back coating + PFAS free water repellent surface coated + Flame Retardant treatment + Ultra-Violet resistant.
<b>Mattress</b>	+ Skin - 210D Welded waterproof fabric + Foam - 38mm Poly Urethane, Poly Ethylene, Aluminum Insulation triple layer body foam + Condensation Mesh - 15mm Polyester coil spacer. + Total 63mm Thick mattress
<b>Seasons</b>	4 Seasons
<b>Sleeping Capacity</b>	2 Adult, 1 Child

### INTERIOR DIMENSIONS

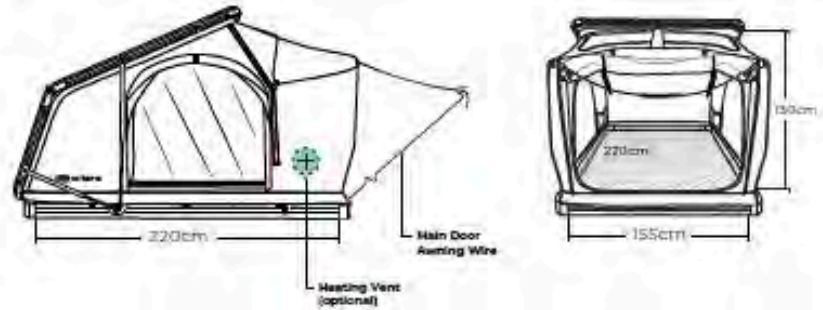

### EXTERIOR DIMENSIONS

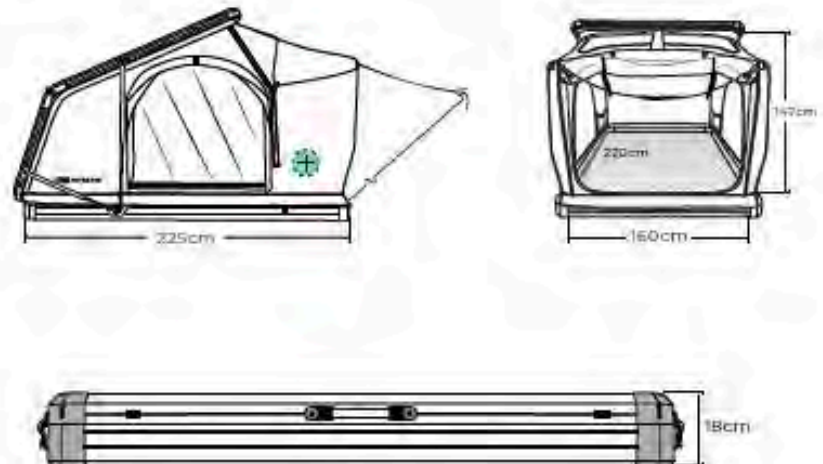

ARB INTREPID

## TENT INSTALLATION 2.0, 2.5 AND 3.0

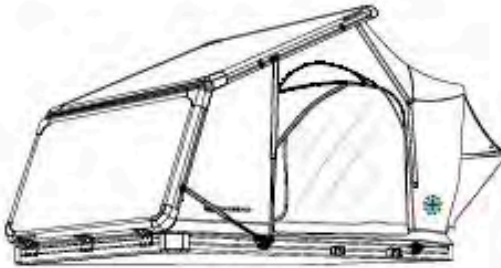

Note: Heavy-duty crossbars should be used when adding extra attachments on top.

<b>Weight</b>	Tent frame & fabric: 77kg (excluding all detachables) + Mattress & condensation mat: 85kg * Ladder: 7.5kg
<b>Interior Dimension</b>	220cm x 155cm x 130cm
<b>Exterior Dimension</b>	225cm x 160cm x 147cm
<b>Height closed/open</b>	18cm / 147cm
<b>Floor</b>	Honeycomb aluminum Aluminum extrusion
<b>Tent Fabric</b>	<b>Body Skin fabrics</b> 300D High Tenacity Double-Rip Polyester + 10,000mm Poly Urethane Waterproof back coating + PFAS free water repellent surface coated + Flame Retardant treatment + Ultra-Violet resistant
<b>Mattress</b>	+ Skin - 210D Welded waterproof fabric + Foam - 38mm Poly Urethane, Poly Ethylene, Aluminum insulation triple layer body foam + Condensation Mesh - 15mm Polyester coil spacer. + Total 63mm Thick mattress
<b>Seasons</b>	4 Seasons
<b>Sleeping Capacity</b>	3 Adults

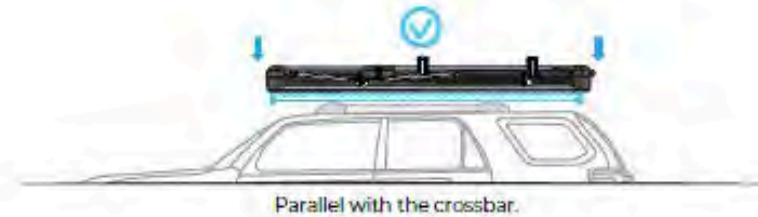

• Parallel with the vehicle's body. • Check balance from front & back side.

## TENT INSTALLATION 2.0, 2.5 AND 3.0

### HARDWARE PREPARATION

Prepare 4 bottom locking sets to assemble (2 extra or optional sets).

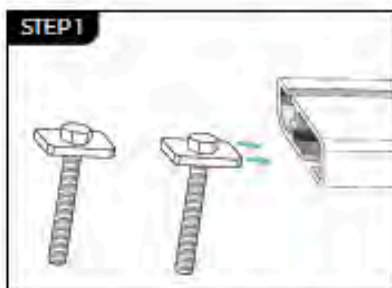

Insert x4 M8 bolts into the C tube at the bottom of tent.

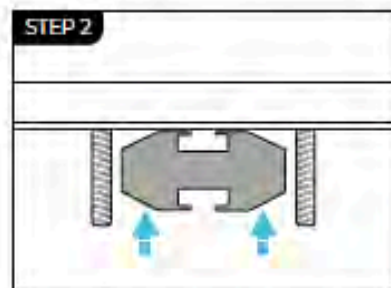

Adjust x2 M8 bolts on the 2 sides of the cross bar as the picture shows.

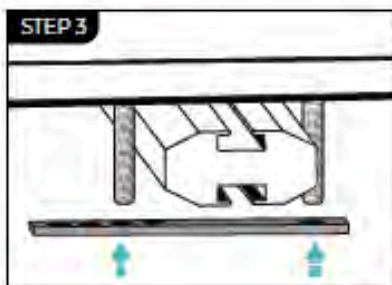

Insert the lock plate to the M8 bolts.

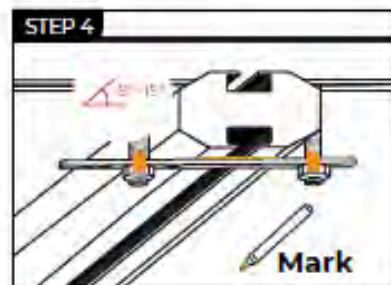

Tighten x2 M8 nuts into the M8 bolts within a 5°-15° plate angle (bolt might break when untightening nut). Mark the installation position, it will help monitor the original position.

**IMPORTANT:** Be sure to check the hardware (roof rail, crossbar, lock plate, etc.) after 16-32 kilometres after installation and after every trip off road to be sure it's still secure.

## INSTALLING RAIL COMPONENTS



Insert x2 M6 T-Nuts into the groove of the top frame.



Move it to the position where you want to install the handle.

### INSTALL THE HANDLE

We recommend installing your ladder hooks and handle on your vehicle after it is mounted, and the handle should be placed in front of the main door (balanced push-up force).

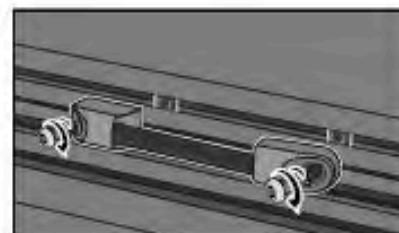

Install the handle, x2 spring washers and x2 M6 bolts, and tighten the bolt.

### INSTALL THE RAINFLY POLE HOLDER

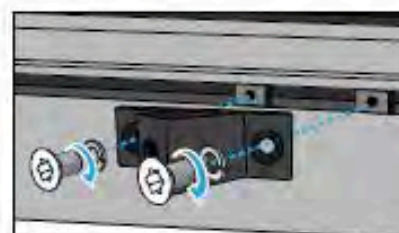

Install the rainfly pole holder, x2 spring washers and x2 M6 bolts, and tighten the bolt.

**Note:** T-nuts left unused in the groove will make more noise.

ARB INTREP10

## HOW TO OPEN THE RTT

STEP 1

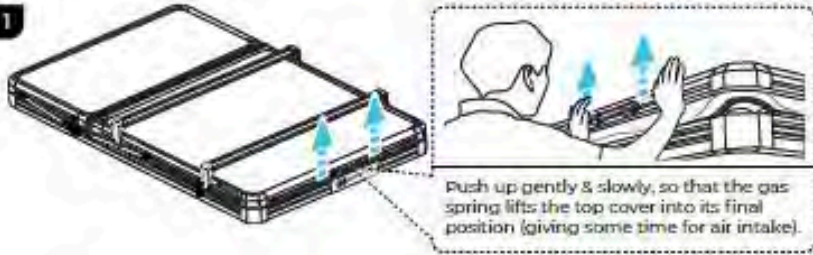

STEP 2

### Caution!

A strong and quick lift up will damage the frame and hinge.



STEP 3

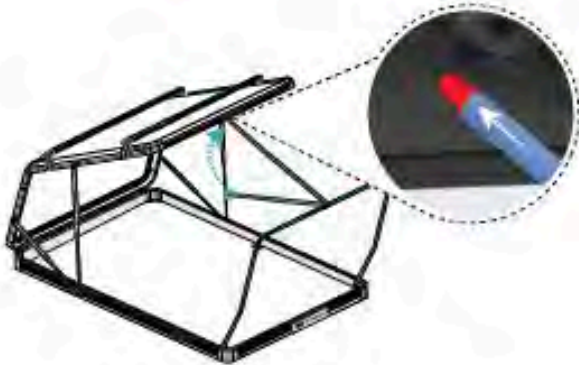

## HOW TO MANAGE GEOMETRIC DOOR

MULTIPLE DOOR - OPENING WAYS:



1. Completely open.

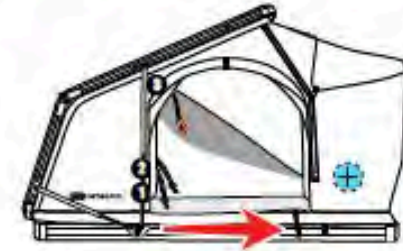

2. Full open (don't need to fold the door).

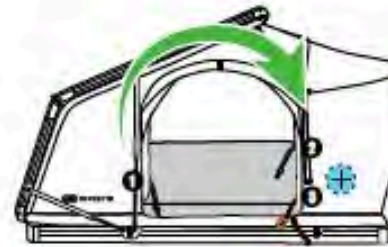

3. Half top opening (ventilation) for raining season.

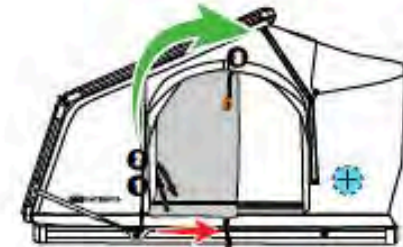

4. Half side opening for snowing season.

- RED COLOR ZIP: Inner door
- GREY COLOR ZIP: Outer door

**Note:** This is very important to help reduce condensation build up during cold and wet nights.

## SETUP INSIDE THE TENT



The two mesh pockets included:  
Zip up and tuck the door fabric inside, then zip down.



The tent has x2 holes on each sides, which a plug can be passed through. When not in use, block with the included foam.

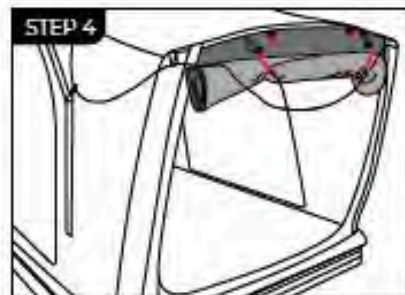
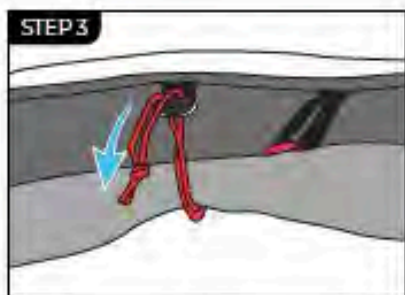
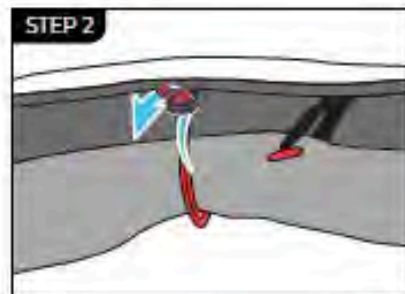
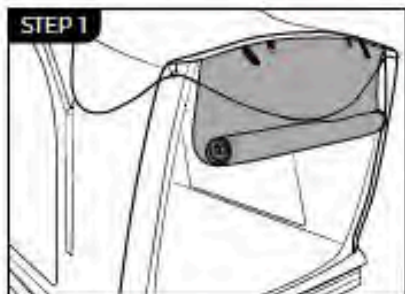

**Front door:** The three large windows can be rolled up and tied neatly with the string all together or single.

## SETUP INSIDE THE TENT

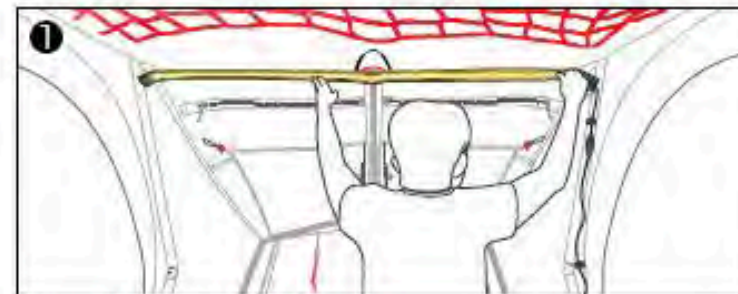

The tent is equipped with a led light in the middle and several O-rings inside.



\* Connection to a power bank or hardwired required.

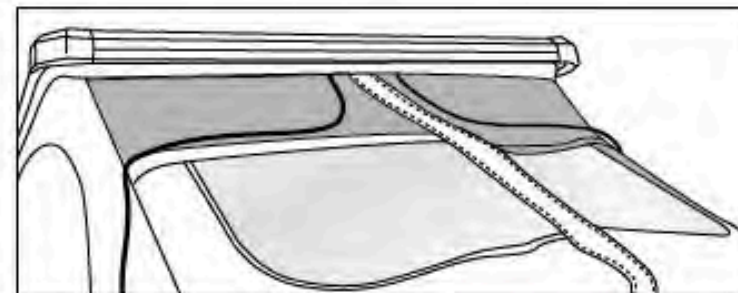

Put up the ventilation support bars - *Should fold before closing!* otherwise it will dent on TPU window.



**ARB** INTREPID

## INSTALLING AWNING WIRE KITS (INCLUDED)



**Note:** Position of the wire bracket changes on wagon vehicles as the position stated contacts the rear tailgate when open.

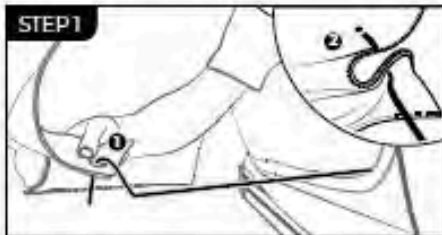

Attach the hook to the eyelet. Choose the eyelet position that works best for you.



Hold the pole handle and gently bend it to insert it into holder.

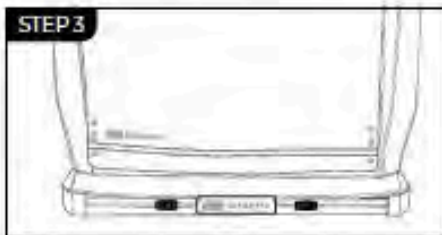

Reverse the bending motion from step 2 to remove the pole.

**Note:** You can insert the rainfly pole from outside tent, or inside tent (Remove with caution).

17

## HOW TO CLOSE THE RTT

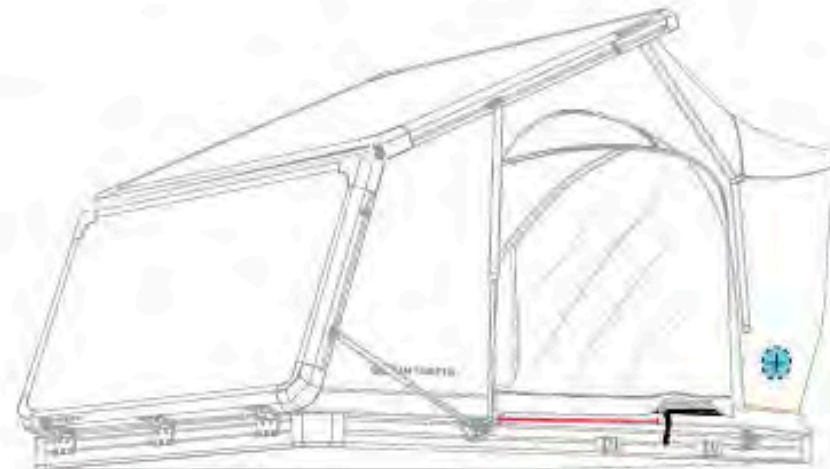

RED ■ 50% closed



Leave the bottom zipper puller (red) close 50%, which prevent water inside when heavy rain.

GREY ■ 100% closed

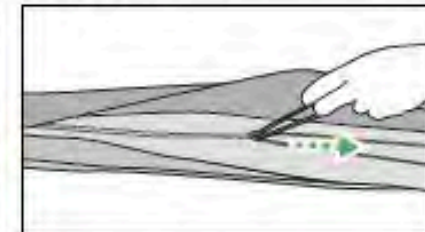

Close before folding

- 1 per side door
- 2 for front door
- 2 ventilation support bar

18

## HOW TO CLOSE THE RTT

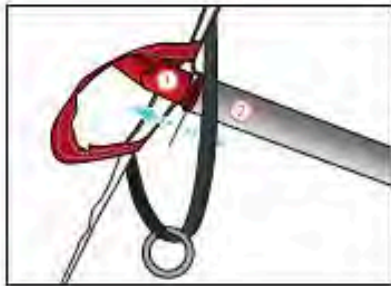

1. Holder
2. Support bar

Fold before closing, otherwise it will dent TPU window.

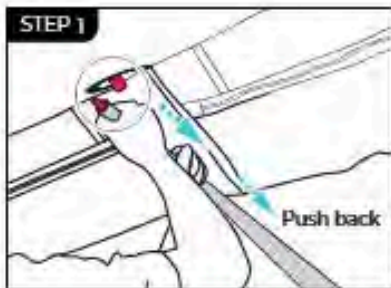

Remove the door frame support bar, and drop it back after you close both side windows.



Next, take off the door frame, as shown in the picture, and lay it on the mattress gently.

**\*Be careful not to pinch the canvas in the frame when closing.**

**Note:** Be sure to place the door frame support bar flat down on the mattress otherwise, it will stamp the mattress.



Grab the rope grip and pull to fold the tent. Pull with your lower body. It is recommended that you do not close it too quick, so the inner air has enough time to go out.

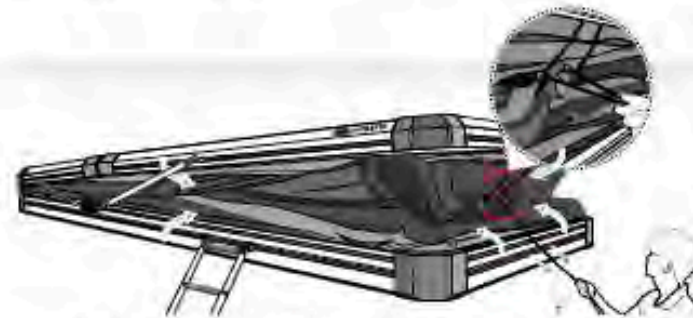

When it's nearly closed, tuck in the fabric from three sides, then put the string inside the tent.



After tent is closed, check side gaps (water penetration path) on both sides.